

MONTAGEZUBEHÖR

Gleitmuttern | Hammer-/Hakenkopfschrauben | Montagebügel

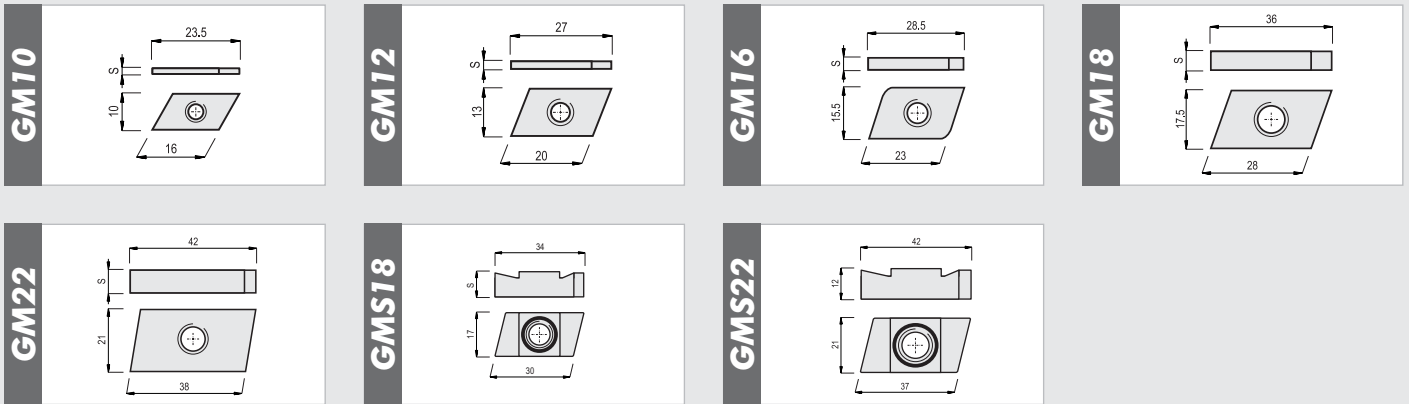

Gleitmuttern ab Seite 21



Hammer-/Hakenkopfschrauben ab Seite 24

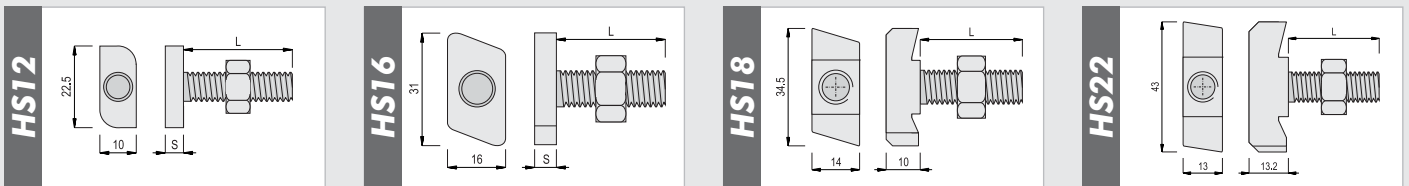

Zubehör ab Seite 26

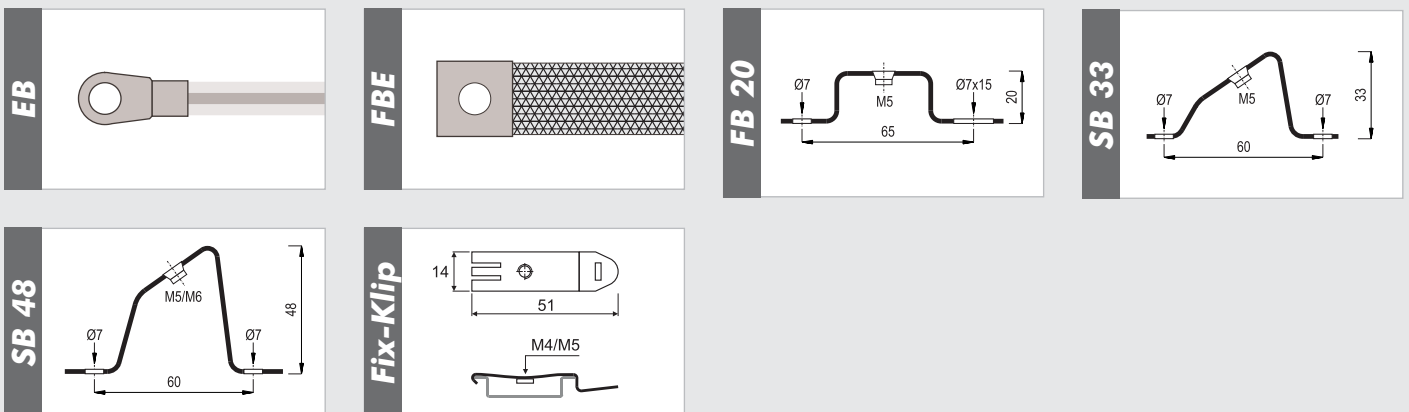

GM10

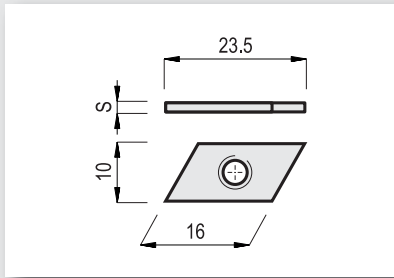
10

BESTELLBEZEICHNUNG	ARTIKEL-NUMMER	WERKSTOFF/VEREDELUNG	GEWINDE	STÄRKE [mm]	VPE [Stück]	GEWICHT [kg/%St.]
GM10 M4	109920	galvanisch verzinkt	M4	2,0	100	0,22
GM10 M5	109974	galvanisch verzinkt	M5	2,5	100	0,22
GM10 M6	109975	galvanisch verzinkt	M6	2,5	100	0,22

passend zu unseren Profilen:

- 20081
- 20103
- 20203

GM12

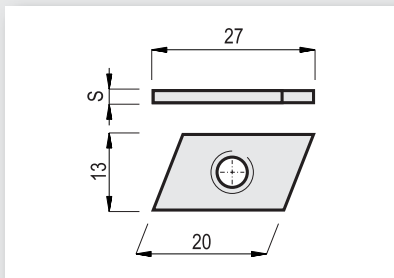
12

BESTELLBEZEICHNUNG	ARTIKEL-NUMMER	WERKSTOFF/VEREDELUNG	GEWINDE	STÄRKE [mm]	VPE [Stück]	GEWICHT [kg/%St.]
GM12 M4	109921	galvanisch verzinkt	M4	2,5	100	0,51
GM12 M5	109922	galvanisch verzinkt	M5	2,5	100	0,50
GM12 M6	109923	galvanisch verzinkt	M6	4,0	100	0,75
GM12 M8	109953	galvanisch verzinkt	M8	4,0	100	0,75

passend zu unseren Profilen:

- 25102
- 28124
- 28154

GM16

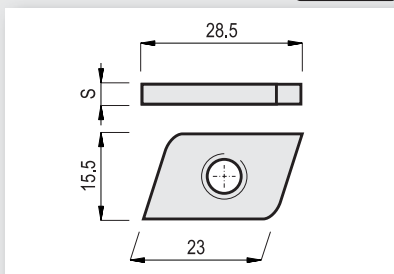
16

BESTELLBEZEICHNUNG	ARTIKEL-NUMMER	WERKSTOFF/VEREDELUNG	GEWINDE	STÄRKE [mm]	VPE [Stück]	GEWICHT [kg/%St.]
GM16 M5	109919	galvanisch verzinkt	M5	4,0	100	1,10
GM16 M6	109924	galvanisch verzinkt	M6	4,0	100	1,10
GM16 M8	109925	galvanisch verzinkt	M8	6,0	100	1,50
GM16 M10	109946	galvanisch verzinkt	M10	6,0	100	1,50

passend zu unseren Profilen:

- 30153
- 30154
- 30243
- 34153
- 35183
- 35184

GM18

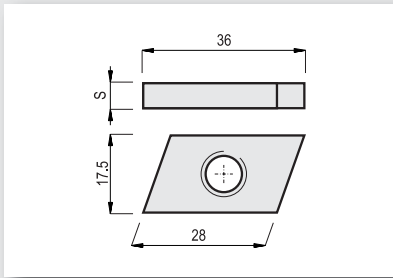
18

passend zu unseren Profilen:

- 40204
- 40224
- 40405

BESTELLBEZEICHNUNG	ARTIKEL-NUMMER	WERKSTOFF/VEREDELUNG	GEWINDE	STÄRKE [mm]	VPE [Stück]	GEWICHT [kg/%St.]
GM18 M6	109926	galvanisch verzinkt	M6	6,0	100	2,25
GM18 M8	109927	galvanisch verzinkt	M8	6,0	100	2,20
GM18 M10	109928	galvanisch verzinkt	M10	6,0	100	2,00
GM18 M12	109948	galvanisch verzinkt	M12	6,0	100	1,80

GMS18

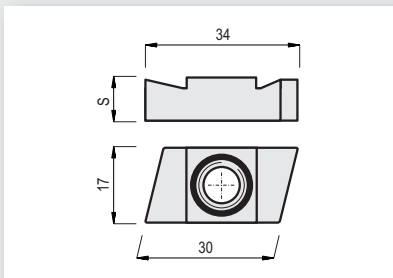
18

passend zu unseren Profilen:

- 40224
- 40405

BESTELLBEZEICHNUNG	ARTIKEL-NUMMER	WERKSTOFF/VEREDELUNG	GEWINDE	STÄRKE [mm]	VPE [Stück]	GEWICHT [kg/%St.]
GMS18 M5	109968	galvanisch verzinkt	M5	10,0	100	3,50
GMS18 M6	109969	galvanisch verzinkt	M6	10,0	100	3,50
GMS18 M8	109970	galvanisch verzinkt	M8	10,0	100	3,50
GMS18 M10	109971	galvanisch verzinkt	M10	10,0	100	3,50
GMS18 M12	109972	galvanisch verzinkt	M12	11,0	100	4,00
GMS18 M16	109973	galvanisch verzinkt	M16	11,0	100	4,00

GM22

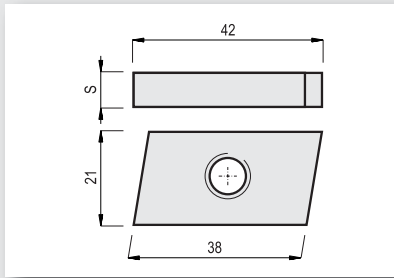
22

BESTELLBEZEICHNUNG	ARTIKEL-NUMMER	WERKSTOFF/VEREDELUNG	GEWINDE	STÄRKE [mm]	VPE [Stück]	GEWICHT [kg/%St.]
GM22 M8	109929	galvanisch verzinkt	M8	8,0	100	4,40
GM22 M10	109930	galvanisch verzinkt	M10	8,0	100	4,40
GM22 M12	109632	galvanisch verzinkt	M12	8,0	100	4,40
GM22 M16	109633	galvanisch verzinkt	M16	8,0	100	4,40

passend zu unserem Profil:

- 50306

GMS22

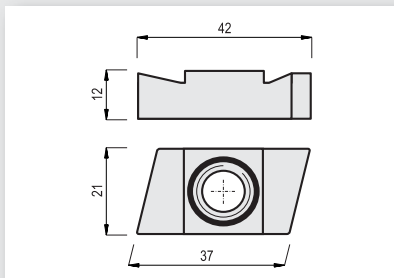
22

BESTELLBEZEICHNUNG	ARTIKEL-NUMMER	WERKSTOFF/VEREDELUNG	GEWINDE	STÄRKE [mm]	VPE [Stück]	GEWICHT [kg/%St.]
GMS22 M8	109634	galvanisch verzinkt	M8	12,0	100	4,40
GMS22 M10	109635	galvanisch verzinkt	M10	12,0	100	4,40
GMS22 M12	109636	galvanisch verzinkt	M12	12,0	100	4,40
GMS22 M16	109637	galvanisch verzinkt	M16	12,0	100	4,40

passend zu unserem Profil:

- 50306

HS12

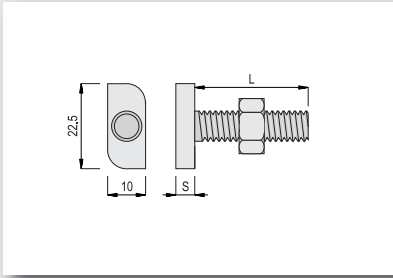
12

passend zu unseren Profilen:

- 25102
- 28124
- 28154

	20 mm	30 mm	35 mm	40 mm	45 mm	50 mm	55 mm	60 mm	65 mm	70 mm	75 mm	80 mm	100 mm	125 mm	150 mm	200 mm	250 mm	300 mm	
M6	✓	✓		✓		✓		✓											
M8	✓	✓		✓		✓		✓				✓	✓	✓	✓				
M10	✓	✓		✓		✓		✓				✓	✓	✓	✓	✓			
M12		✓				✓						✓							

Typschlüssel: HS12 Gewinde x Länge

Beispiel: HS12 M8x40

HS16

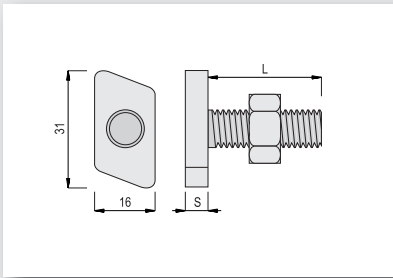
16

passend zu unseren Profilen:

- 30153
- 34153
- 30154
- 35183
- 30243
- 35184

	20 mm	30 mm	35 mm	40 mm	45 mm	50 mm	55 mm	60 mm	65 mm	70 mm	75 mm	80 mm	100 mm	125 mm	150 mm	200 mm	250 mm	300 mm	
M6																			
M8	✓	✓		✓		✓													
M10		✓		✓		✓						✓							
M12																			

Typschlüssel: HS16 Gewinde x Länge

Beispiel: HS16 M8x50

HS18

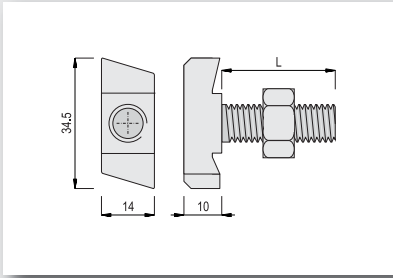
18

passend zu unseren Profilen:

- 40224
- 40405

	20 mm	30 mm	35 mm	40 mm	45 mm	50 mm	55 mm	60 mm	65 mm	70 mm	75 mm	80 mm	100 mm	125 mm	150 mm	200 mm	250 mm	300 mm	
M10	✓	✓		✓		✓		✓		✓		✓	✓						
M12	✓	✓		✓		✓		✓		✓		✓	✓	✓	✓	✓			
M16		✓		✓		✓		✓		✓		✓	✓	✓	✓	✓	✓	✓	
M20																			✓

Typschlüssel: HS18 Gewinde x Länge

Beispiel: HS18 M12x70

HS22

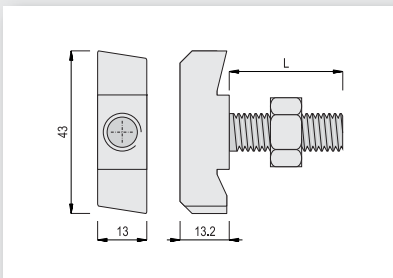
22

passend zu unserem Profil:

- 50306

	20 mm	30 mm	35 mm	40 mm	45 mm	50 mm	55 mm	60 mm	65 mm	70 mm	75 mm	80 mm	100 mm	125 mm	150 mm	200 mm	250 mm	300 mm	
M10		✓		✓		✓						✓							
M12		✓		✓		✓		✓				✓	✓	✓	✓	✓			
M16		✓		✓		✓		✓				✓	✓	✓	✓	✓			✓
M20			✓		✓		✓		✓		✓		✓	✓	✓	✓			✓

Typschlüssel: HS22 Gewinde x Länge

Beispiel: HS22 M16x80

Erdungsbänder



BESTELLBEZEICHNUNG	ARTIKEL-NUMMER	QUERSCHNITT	LÄNGE	VPE	GEWICHT [kg/%St.]
EB 170/4	190001	4 mm ²	170 mm	5 St.	1,2
EB 300/4	190002	4 mm ²	300 mm	5 St.	1,7
EB 170/16	190003	16 mm ²	170 mm	5 St.	3,6
EB 300/16	190004	16 mm ²	300 mm	5 St.	5,7
EB 170/25	190005	25 mm ²	170 mm	5 St.	6,3
EB 300/25	190006	25 mm ²	300 mm	5 St.	10,1

Standardausführung mit M8-Ringkabelschuh
 Kabelfarbe: grün/gelb
 weitere Typen auf Anfrage

Flachbänderder

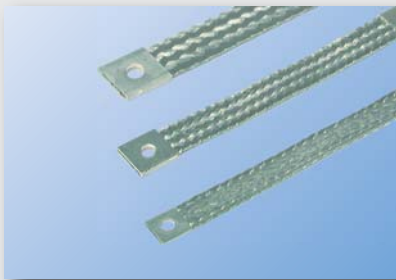

- verzinkt
- hochflexibel
- gelochte Endhülsen

weitere Typen auf Anfrage

BESTELLBEZEICHNUNG	ARTIKEL-NUMMER	QUERSCHNITT	LÄNGE	VPE	GEWICHT [kg/%St.]
FBE 200/10 M6	190010	10 mm ²	200 mm	10 St.	2,5
FBE 300/10 M6	190011	10 mm ²	300 mm	10 St.	3,5
FBE 150/16 M8	190013	16 mm ²	150 mm	10 St.	3,8
FBE 200/16 M8	190014	16 mm ²	200 mm	10 St.	4,6
FBE 300/16 M8	190015	16 mm ²	300 mm	10 St.	6,2
FBE 450/16 M8	190016	16 mm ²	450 mm	10 St.	8,5
FBE 150/25 M8	190018	25 mm ²	150 mm	10 St.	6,3
FBE 200/25 M8	190019	25 mm ²	200 mm	10 St.	7,6
FBE 300/25 M8	190020	25 mm ²	300 mm	10 St.	10,0
FBE 450/25 M8	190021	25 mm ²	450 mm	10 St.	14,0

Montagehilfen



SB 48, SB 33, FB 20, Fix-Klip

BESTELLBEZEICHNUNG	ARTIKEL-NUMMER	WERKSTOFF/VEREDELUNG	GEWINDE	HÖHE	VPE [Stück]	GEWICHT [kg/%St.]
FB 20 M5	109910	galv. verzinkt	M5	20 mm	10 St.	2,8
SB 33 M5	109911	dickschichtpass.	M5	33 mm	10 St.	2,8
SB 48 M5	109912	galv. verzinkt	M5	48 mm	10 St.	3,4
SB 48 M6	109914	galv. verzinkt	M6	48 mm	10 St.	3,4
Fix-Klip M4	109915	vernickelt	M4		100 St.	0,4
Fix-Klip M5	109916	vernickelt	M5		100 St.	0,4

