

# 634.034 DCGM 43 T42

DC MOTOR WITH WORM GEAR

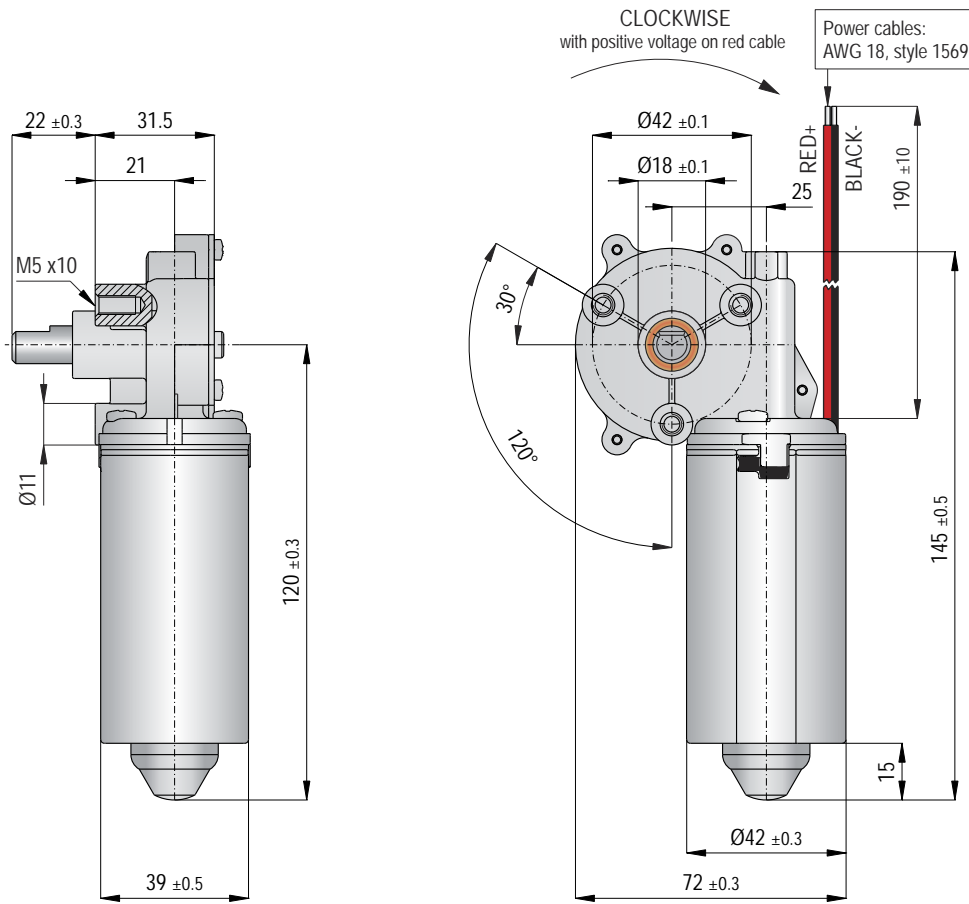

Ø 43 mm



24 V/DC



35 min<sup>-1</sup>



10 Nm



1,0 nF  
4,7 µH



-

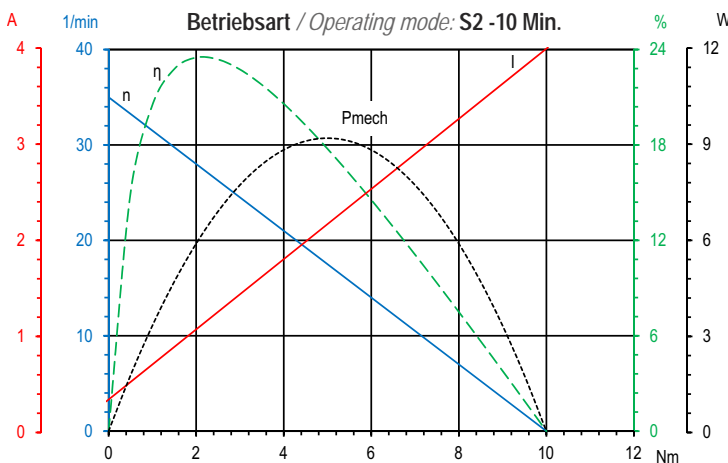
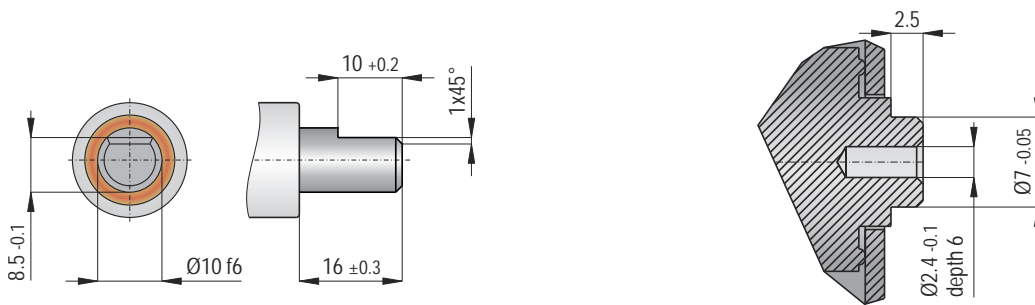

## Technische Daten / Technical data

Nennspannung / Nominal voltage **24 V/DC**

Leerlaufdrehzahl / No-load speed **35 min<sup>-1</sup>**

Nennmoment / Nom. torque **2 Nm**

Maximalmoment / Max. torque **10 Nm**

Hall-Sensor / Hall-sensor **-**

Zahnradwerkstoff / Gear material **Kunststoff / Plastic**

Übersetzung / Gear ratio **62:1**

Schutzart / Protection class **IP 20**

Gewicht / Weight **0,7 kg**

Diese Angaben sind Mittelwerte gemessen im kalten Zustand des Motors. Abweichungen von ±10% sind möglich. Technische Änderungen vorbehalten.

These data are measured average values at cold engine. Deviations from ±10% are possible. Subject to change without notice.



GERDT SEEFRID GMBH • Theodor-Heuss-Straße 35 • DE-61118 Bad Vilbel-Dortelweil  
Fon +49 (0)6101 5252-0 • Fax +49 (0)6101 5252-18 • vertrieb@seefrid.de • www.seefrid.com

## Allgemeines

Alle Angaben zu DC-Motoren und DC-Linearantrieben sind Mittelwerte gemessen im kalten Zustand. Abweichungen von  $\pm 10\%$  sind möglich. Technische Änderungen vorbehalten.

Aktuelle Informationen finden Sie auf unserer Internetseite unter [www.seefrid.com](http://www.seefrid.com).

## General

All data to DC motors and DC linear actuators are measured average values at cold engine. Deviations from  $\pm 10\%$  are possible. Subject to change without notice.

Current information you will find on our website [www.seefrid.com](http://www.seefrid.com).

## Symbole / Symbols



Nennspannung [V]  
Nominal voltage [V]



Leerlaufdrehzahl [ $\text{min}^{-1}$ ]  
No-load speed [rpm]



Maximalmoment [Nm]  
Maximum torque [Nm]



Hubhöhe [mm]  
Stroke [mm]



Leerlaufgeschwindigkeit [mm/s]  
No-load speed [mm/s]



max. Hubkraft [N]  
max. lift power [N]



$\varnothing$  Motortopf [mm]  
Motor diameter [mm]



Motorbefestigung [mm]  
Mounting of motor [mm]



Hall-Sensor  
Hall sensor



EMV Entstörung  
EMC filter

## Allgemeines Anschlussschema für Motoren mit eingebautem Hall-Sensor

General connection diagram for motors with built-in Hall sensor

### • Anschlussschema mit 1-Kanal Hall-Sensor

Connection diagram with a 1-channel Hall sensor

### • Anschlussschema mit 2-Kanal Hall-Sensor

Connection diagram with a 2-channel Hall sensor

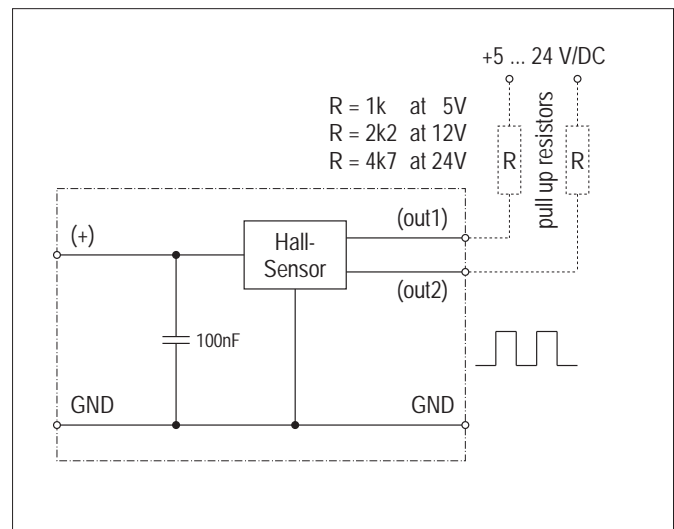
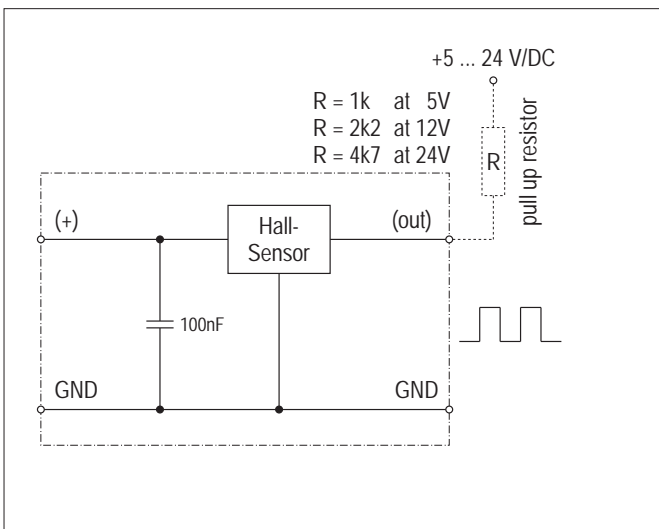

**Umrechnungen** (für die Praxis gerundete Werte) / *Conversion (rounded values)*

• **Kräfte** / *Forces*

1 N = 0,1 kg = 100 g                      1 kg = 10 N = 10.000 mN

• **Drehmomente** / *Torques*

1 Nm = 10.000 g/cm = 10 kg/cm                      1 kg/cm = 0,1 Nm = 10 Ncm  
 1 Ncm = 100 g/cm = 0,1 kg/cm                      1 g/cm = 1·10<sup>-4</sup> Nm = 1·10<sup>-2</sup> Ncm

**Kennlinie** / *Diagram*

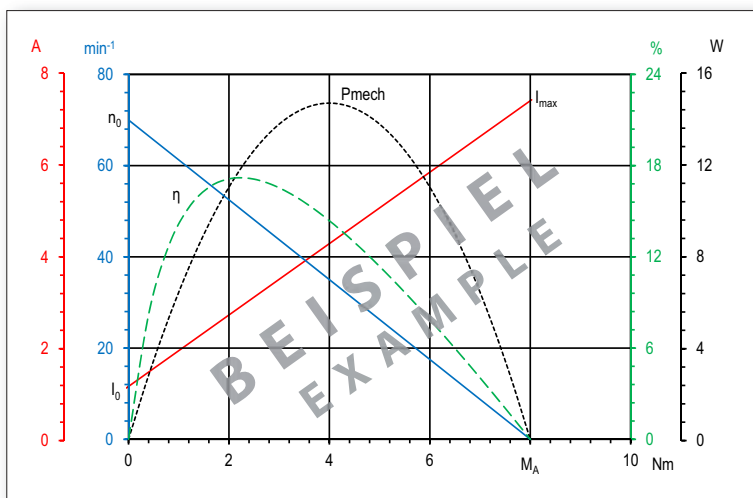

**Legende** / *Description*

- $n_0$  = Leerlaufdrehzahl / *No-load speed* [min<sup>-1</sup>]
- $\eta$  = Wirkungsgrad / *Efficiency* [%]
- $P_{mech}$  = mech. Leistung / *Mech. power* [W]
- $I_0$  = Leerlaufstrom / *No load current* [A]
- $I_{max}$  = Maximalstrom / *Max. current* [A]
- $M$  = Drehmoment / *Torque* [Nm]
- $M_A$  = Anlaufmoment / *Starting torque* [Nm]

**EMV-Entstörung** / *EMC filter*

Ein Teil unserer DC-Motoren und DC-Linearantriebe sind mit Entstörkomponenten ausgestattet. Hierbei handelt es sich ausschließlich um eine Grundentstörung. Die tatsächlich notwendige Entstörung ist anwendungsabhängig zu ermitteln.

*Some of our DC motors and DC linear actuators have built-in EMC filter components. This is only a basic interference suppression. The really needed interference suppression must be determined in combination with the complete machine.*

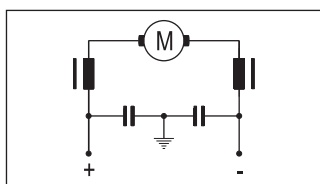

Kapazitive und induktive EMV-Entstörung. *EMC suppression with capacitor and choke.*

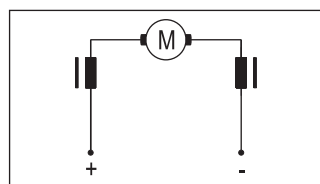

Induktive EMV-Entstörung. *EMC suppression with choke.*

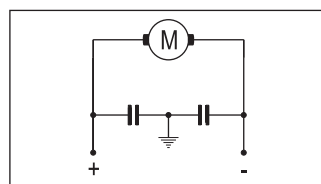

Kapazitive EMV-Entstörung. *EMC suppression with capacitor.*

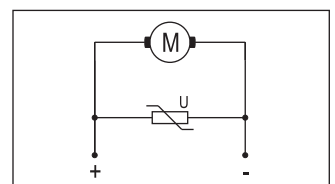

EMV-Entstörung mit einem Varistor. *EMC suppression with a varistor.*

Beispiel: / *Example:*



1,0 nF  
4,7 µH

Beispiel: / *Example:*



- nF  
4,7 µH

Beispiel: / *Example:*



1,0 nF  
- µH

Beispiel: / *Example:*



Varistor